



horngshingt看.com



HORNG SHING HARDWARE INDUSTRIAL CO., LTD

No. 368, Xinzhong Rd., Zhongliu Vil, Hemei Town,
Changhua County 50842, Taiwan. (R.O.C.)
TEL: +886-4-7367961 FAX: +886-4-7363656
EMAIL: hstw1995@gmail.com

HORNG SHING

Aluminum door and window
building materials, hardware parts





HORNG SHING

HS, YOUR BEST CHOICE.

About Us

Established in 1995, Horng Shing Hardware designs, engineers and manufactures products for the building material, hardware and accessory industrial.

Horng Shing strive to uphold the highest standards of service and responsibility in the building hardware industry and well experienced specialized in zinc and aluminum alloy die casting, other manufacturing capabilities include aluminum extrusion, state of CNC machining, stamping, forming, and coating.

We have the capability to efficiently produce high volumes of products and is your ideal of OEM partner as well.

Horng Shing listed professionalism standard regarded as the highest indicator of the company. Continues to implement the business philosophy of sustainable operation, and aims to create growth value with customers and process suppliers. Sincere providing the best living from high efficiency product and service for the users.



index

	3
SLIDING DOOR PULL LOCKS / CAVITY SLIDING DOOR HANDLE	
	7
HANDLE SERIES	
	9
BROKEN BRIDGE ALUMINUM / TILT AND TURN / SCREEN WINDOW HANDLE	
	11
FLAG HINGES	
	13
METAL CORNER CONNECTOR (DIY PRODUCTS)	
	15
DOOR FLUSH BOLT/ DOOR STOPPER /LIMITER (DIY PRODUCTS)	
	17
WINDOW LOCK - CRESCENT LOCK	

Expertise,
Eeperience,
Quality Standard,
Relations.

SLIDING DOOR PULL LOCKS / CAVITY SLIDING DOOR HANDLE

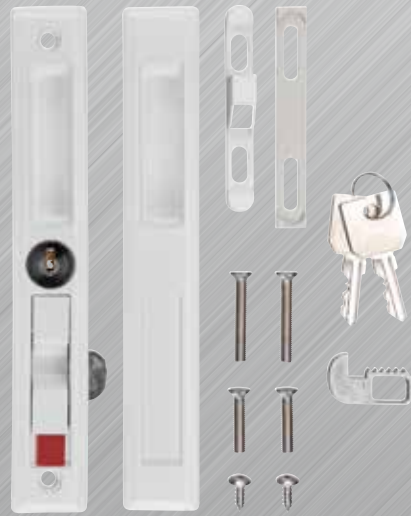

▲ HD04-007

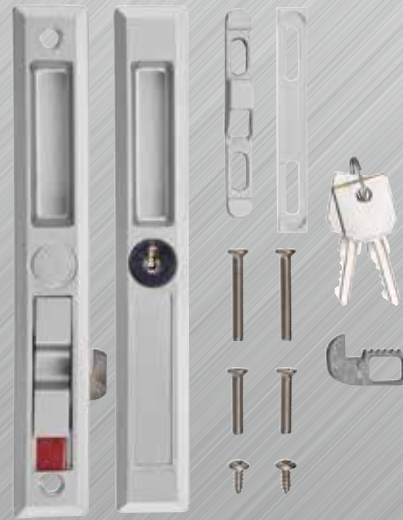

▲ HD04-008



▲ HD04-016

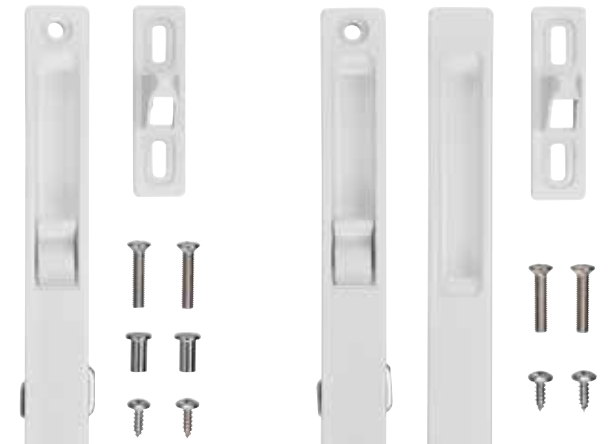

▲ HD04-011

▲ HD04-001



▲ HD04-014



▲ HD04-018



▲ HD04-006



▲ HD04-010

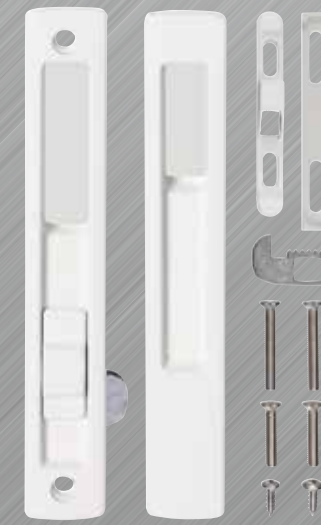

▲ HD04-019

Expertise,
Eperience,
Quality Standard,
Relations.

SLIDING DOOR PULL LOCKS / CAVITY SLIDING DOOR HANDLE



▲ HD01-013



▲ HD01-010



▲ HW04-007



▲ HW04-003



▲ HW04-001
Flat



▲ HW04-002
Dome



▲ HD08-013



Expertise,
Eperience,
Quality Standard,
Relations.

HANDLE SERIES



▲ HD01-007-01



▲ HD01-002-01

Tube diameter	Tube center distance dimension
25 mm	229.4 mm
32 mm	305 mm

More dimension customization available.



▲ HW08-XF



▲ HC09-001
Material: ABS



▲ HD12-07

Expertise,
Eperience,
Quality Standard,
Relations.

BROKEN BRIDGE ALUMINUM / TILT AND TURN / SCREEN WINDOW HANDLE

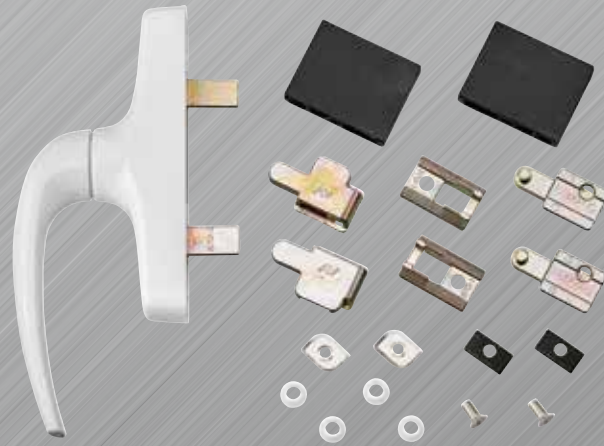

▲ HW03-004



▲ HW03-008



▲ HD02-001



▲ HD02-004



▲ HW09-005



▲ HW09-006



▲ HW03-007



▲ HW03-005



▲ HW03-010



▲ HW03-002

Dimension customization available.



▲ HW03-017



▲ HW03-018

Expertise,
Eperience,
Quality Standard,
Relations.

FLAG HINGES



▲ HD07-001



▲ HD07-008



▲ HD07-009



▲ HD07-002

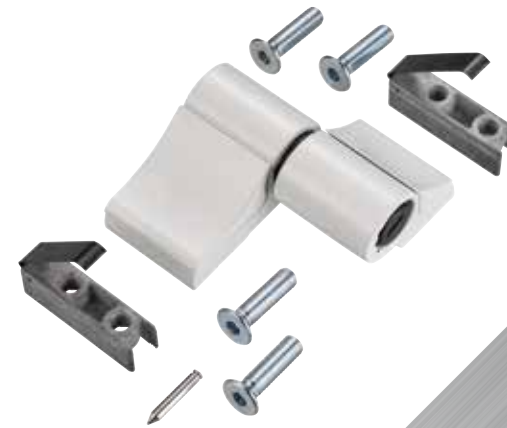

▲ HD07-011



▲ HD07-005



▲ HD07-006



▲ HD07-010

Expertise,
Eperience,
Quality Standard,
Relations.

METAL CORNER CONNECTOR (DIY PRODUCTS)



▲ HW04-010

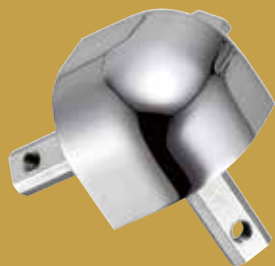

▲ HT01-001



▲ HT01-002



▲ HT01-005



▲ HT01-006



▲ HN01-002-713



▲ HD01-001
Flower design Zinc handle

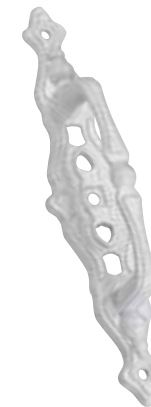

▲ HD01-012



▲ HD10-01
Door brush strip
Din. 20mm x 1m



▲ HD10-02
Door rubber strip
Din. 37.6mm x 1.1m



▲ HT01-009



▲ HT01-007



▲ HT01-008



▲ HT01-010

Expertise,
Eeperience,
Quality Standard,
Relations.

DOOR FLUSH BOLT/ DOOR STOPPER / LIMITER (DIY PRODUCTS)



▲ HN01-001



▲ HD05-003
Din. 4"



▲ HD05-002
Din. 7"



▲ HD05-001



▲ HD05-016



▲ HD05-017



▲ HD05-018



▲ HS01-010
Limiter



▲ HD05-014
Din. 4", 5"



▲ HD05-019
Din. 4", 5"

Expertise,
Eperience,
Quality Standard,
Relations.

WINDOW LOCK - CRESCENT LOCK



▲ HD08-001

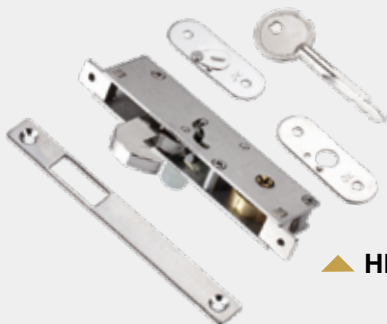

▲ HD08-006



▲ HS01-018



▲ HD01-008
Auxiliary handle



▲ HD03-001



▲ HD03-007



▲ HW01-019



▲ HW01-049



▲ HW01-038

◀ Espagnolette rod of
aluminum window

• related product-HW01-019

• related product



▲ HW01-011



▲ HW01-012



▲ HW01-014